

# Distinctive Characteristics

Carefully designed light diffusion and filtering system produces bright, full surface illumination with front panel relamping.

Spot illumination available in single and bicolor LEDs.

Choice of super bright LEDs in white, green, and blue in addition to standard or bright red, amber, and green LEDs.

Stainless steel clips provide secure mounting with a wide range of panel thicknesses.

Latchdown feature gives indication of circuit status. Audible and tactile feedback with smooth and responsive operation.

Snap-action contact mechanism gives long electrical life and sensitivity of actuation.

Combination solder lug and .110" quick connect terminals are epoxy sealed to prevent entry of flux, dust, and other contaminants.

Panel sealed model meets IP65 of IEC60529 specifications (similar to NEMA 4 & 13).

Compact switch design minimizes behind panel depth.

Nonilluminated models available and shown in the Pushbutton section.

Matching indicators available and shown at the end of Section M.



Actual Size

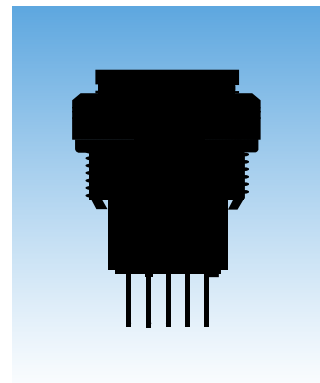

# General Specifications

## Electrical Capacity (Resistive Load)

- Power Level (silver):** 3A @ 125V AC or 3A @ 250V AC or 3A @ 30V DC
  - Logic Level (gold):** 0.4VA maximum @ 28V AC/DC maximum  
(Applicable Range 0.1mA ~ 0.1A @ 20mV ~ 28V)
- Note: Find additional explanation of operating range in Supplement section.

## Other Ratings

- Contact Resistance:** 50 milliohms maximum for silver; 100 milliohms maximum for gold
- Insulation Resistance:** 200 megohms minimum @ 500V DC
- Dielectric Strength:** 1,000V AC minimum between contacts for 1 minute minimum;  
1,500V AC minimum between contacts & case for 1 minute minimum
- Mechanical Life:** 1,000,000 operations minimum for momentary circuit  
200,000 operations minimum for maintained circuit
- Electrical Life:** 100,000 operations minimum
- Nominal Operating Force:** 5.39N
- Contact Timing:** Nonshorting (break-before-make)
- Travel:** Momentary: Pretravel .059" (1.5mm); Overtravel .059" (1.5mm); Total Travel .118" (3.0mm)  
Maintained: Pretravel .087" (2.2mm); Overtravel .031" (0.8mm); Total Travel .118" (3.0mm)

## Materials & Finishes

- Housing:** Glass fiber reinforced polyamide (UL94V-0)
- O-ring:** Nitrile butadiene rubber
- Inner Seal:** Silicone rubber
- Movable Contact:** Silver alloy or copper with gold plating
- Stationary Contacts:** Silver alloy or copper with gold plating
- Base:** Liquid crystal polymer (UL94V-0)
- Switch Terminals:** Phosphor bronze with silver or gold plating
- Lamp Terminals:** Brass with silver plating

## Environmental Data

- Operating Temp Range:** -25°C through +50°C (-13°F through +122°F)  
Note: When used with a polyvinyl chloride splash cover, the lowest limit is 0°C (32°F)
- Humidity:** 90 ~ 95% humidity for 96 hours @ 40°C (104°F)
- Vibration:** 10 ~ 55Hz with peak-to-peak amplitude of 1.5mm traversing the frequency range & returning in 1 minute; 3 right angled directions for 2 hours
- Shock:** 50G (490m/s<sup>2</sup>) acceleration (tested in 6 right angled directions, with 5 shocks in each direction)
- Sealing:** IP65 of IEC60529 standard (similar to NEMA 4 & 13)

## Installation

- Mounting Torque:** 1.96Nm (17.35 lb•in) maximum
- Cap Installation Force:** 3.92N maximum downward force on cap
- Quick Connect Force:** 52.95N maximum downward force on connector
- Soldering Time & Temperature:** Manual Soldering: See Profile A in Supplement section.

## Standards & Certifications

- Flammability Standards:** UL94V-0 housing & base
- UL & C-UL Recognized:** All models recognized at 3A @ 125V or 250V AC or 0.4VA @ 28V AC/DC maximum;  
UL File No. WOYR2.E44145; add "/U" to end of part number to order UL mark on switch.  
C-UL File No. WOYR8.E44145; add "/C-UL" to end of part number to order C-UL mark on switch.
- CSA Certified:** All models certified at 3A @ 125V or 250V AC or 0.4VA @ 28V AC/DC maximum;  
CSA File Nos. 023535-0-000; add "/C" to end of part number to order CSA mark on switch.



TYPICAL SWITCH ORDERING EXAMPLE

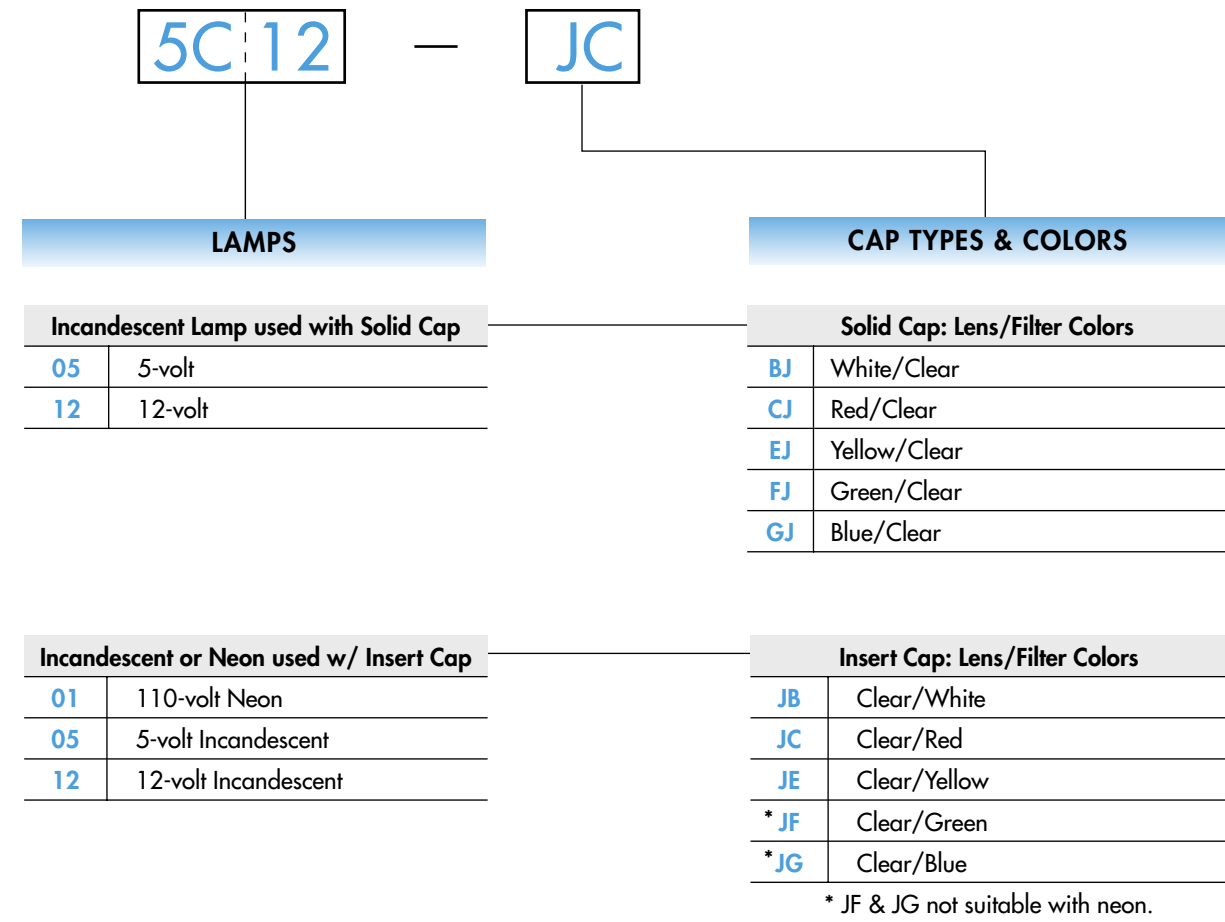
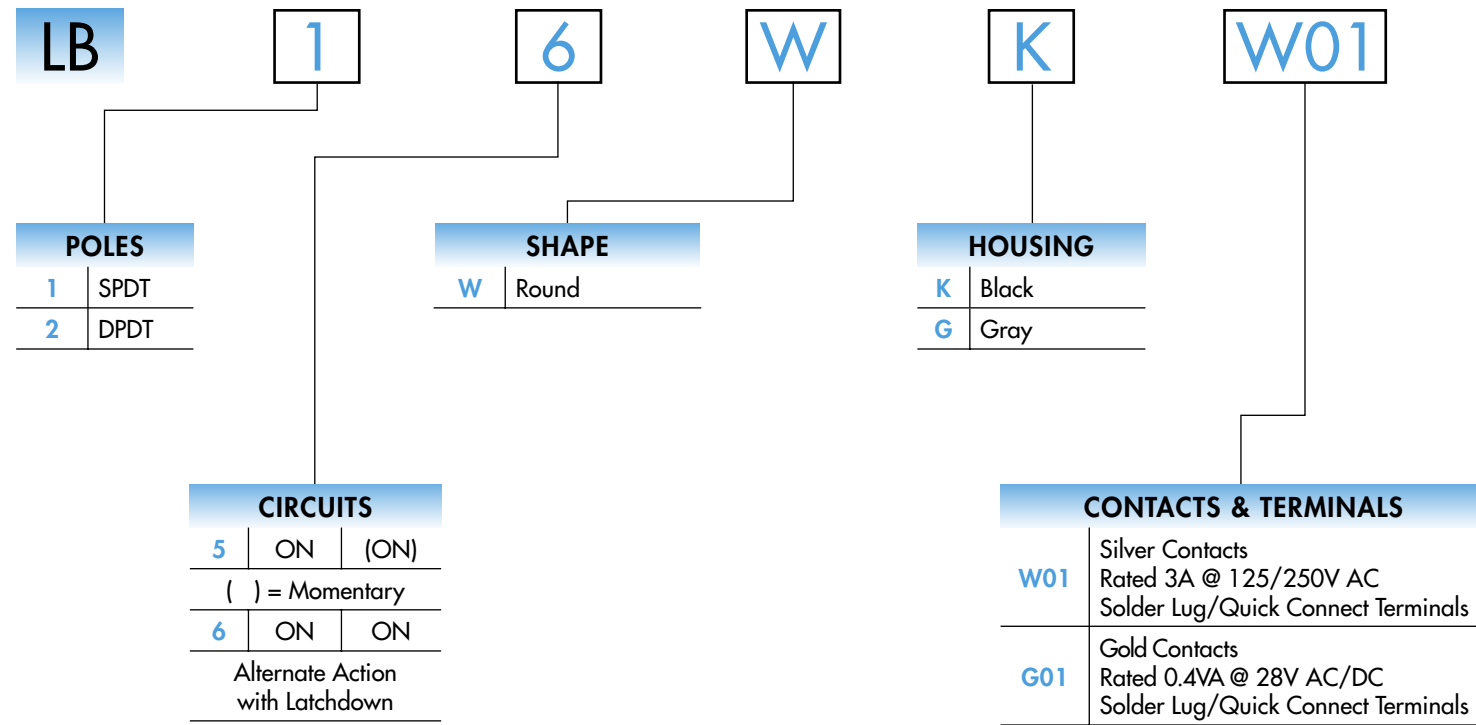

DESCRIPTION FOR TYPICAL ORDERING EXAMPLE

LB16WKW01-5C12-JC

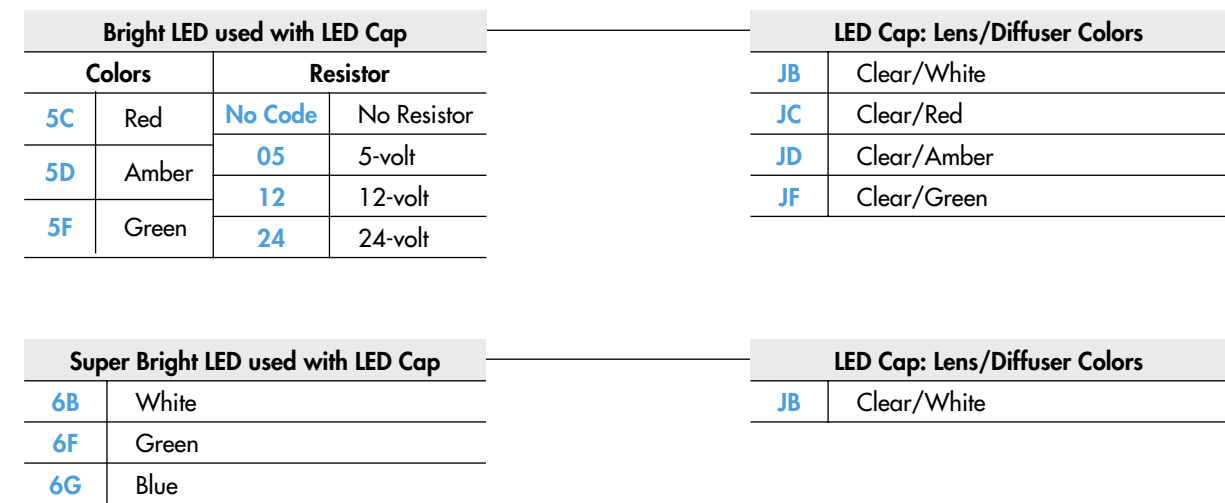

**IMPORTANT:**



Switches are supplied without UL, C-UL & CSA markings unless specified. Specific models & ratings noted on General Specifications page.

### POLES & CIRCUITS

Pole	Model	Plunger Position ( ) = Momentary		Connected Terminals		Throw & Switch/Lamp Schematics
		Normal	Down	Normal	Down	
SP	LB15 *LB16	ON ON	(ON) ON	1-3	1-2	Notes: Switch is marked with NC, NO, COM, L+, L-. Lamp circuit is isolated and requires external power source. 
DP	LB25 *LB26	ON ON	(ON) ON	1-3 4-6	1-2 4-5	

\* When in latchdown position for the alternate circuit, cap position is .039" (1.0mm) above the built-in bezel.

### SHAPE & PANEL CUTOUT

**W** .866" (22.0mm)  
Round

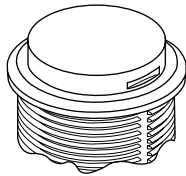

Recommended Panel Thickness:  
.039" ~ .157" (1.0mm ~ 4.0mm)

Recommended Panel Thickness with Splash Cover:  
.039" ~ .138" (1.0mm ~ 3.5mm)

Overtightening the mounting nut AT074 may damage the switch housing.

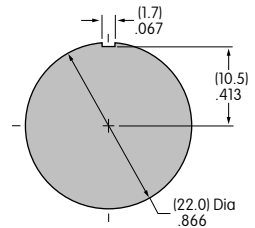

### HOUSING

Housing Colors Available:

**K** Black

**G** Gray

### CONTACT MATERIALS, RATINGS & TERMINALS

**W01** Silver Contacts

**Power Level**  
3A @ 125V AC & 250V AC

Solder Lug/Quick Connect

**G01** Gold Contacts

**Logic Level**  
0.4VA max. @ 28V AC/DC max.

Optional PCB adaptors AT711 & AT712 available; illustrated in previous snap-in subsection.

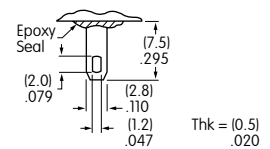

Complete explanation of operating range in Supplement section.

### INCANDESCENT & NEON LAMP CODES & SPECIFICATIONS

AT607 & AT607N



T-1 Bi-pin

		<b>05</b>	<b>12</b>	<b>01</b> *
	AT607 Incandescent 5-volt or 12-volt; AT607N Neon 110-volt			
Voltage	V	5V AC	12V AC	110V AC
Current	I	115mA	60mA	1.5mA
Endurance	Avg. Hours	7,000		10,000
Ambient Temp. Range		-25°C ~ +50°C		

The electrical specifications shown are determined at a basic temperature of 25°C. Lamp circuit is isolated and requires external power source.

\* Recommended Resistors for Neon:  
33K ohms for 110V AC;  
100K ohms for 220V AC

### LED COLORS & SPECIFICATIONS



The electrical specifications shown are determined at a basic temperature of 25°C. LED circuit is isolated and requires external power source. Polarity marks are on the switch.

If the source voltage exceeds the rated voltage, a ballast resistor is required.

The resistor value can be calculated by using the formula in the Supplement section.

Additional lamp detail is shown in the Accessories & Hardware section.

#### Bright LED without Resistor

<b>AT635</b>  LEDs are colored in OFF state.     T-1 1/2 Bi-pin	Color Codes	Red <b>5C</b>	Amber <b>5D</b>	Green <b>5F</b>	<b>No Code</b> No Resistor
	Forward Peak Current			$I_{FM}$	30mA
	Continuous Forward Current			$I_F$	20mA
	Forward Voltage			$V_F$	1.9V
	Reverse Peak Voltage			$V_{RM}$	5V
	Current Reduction Rate Above 25°C			$\Delta I_F$	0.42mA/°C
	Ambient Temperature Range				-25° ~ +50°C

#### Bright LED with Resistor

<b>AT627 with Resistor</b>    T-1 Bi-pin	Color Codes:	Red <b>5C</b>	Amber <b>5D</b>	Green <b>5F</b>	Resistor Codes <b>05</b> <b>12</b> <b>24</b>
	Forward Peak Current			$I_{FM}$	—
	Continuous Forward Current			$I_F$	52mA
	Forward Voltage			$V_F$	5V
	Reverse Peak Voltage			$V_{RM}$	4V
	Current Reduction Rate Above 25°C			$\Delta I_F$	0.50mA/°C
	Ambient Temperature Range				-25° ~ +50°C

AT627  
5-volt  
4-element  
with Resistor

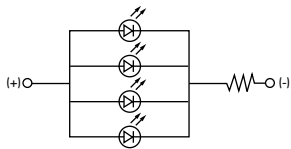

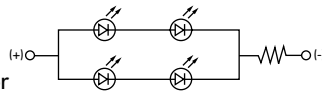

AT627  
12-volt  
4-element  
with Resistor

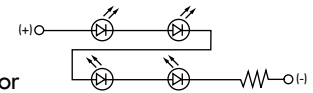

AT627  
24-volt  
4-element  
with Resistor



#### Super Bright Single Element LED

<b>AT625G Blue</b> <b>AT631B White</b> <b>AT632F Green</b>     T-1 Bi-pin				<b>6B</b>	<b>6F</b>	<b>6G</b>
	Color	White	Green	Blue		
	Forward Peak Current	$I_{FM}$	30mA	30mA	30mA	
	Continuous Forward Current	$I_F$	20mA	20mA	20mA	
	Forward Voltage	$V_F$	3.6V	3.5V	3.6V	
	Reverse Peak Voltage	$V_{RM}$	5V	5V	5V	
	Current Reduction Rate Above 25°C	$\Delta I_F$	0.50mA/°C			
	Ambient Temperature Range		-25° ~ +50°C			

### CAP TYPES & COLOR COMBINATIONS

Color Codes: B White C Red D Amber E Yellow F Green G Blue J Clear

#### Solid Cap for Incandescent Lamp

Lens/Filter  
Colors Available:

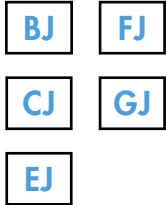

AT4054

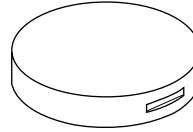
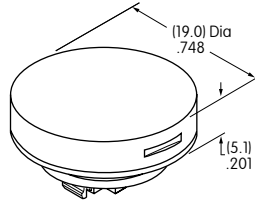

Translucent  
Colored Lens

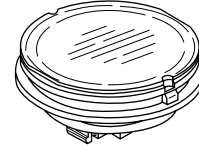

Transparent  
Clear Filter



Lamp  
AT607

Material: Polycarbonate Finish: Glossy

#### Insert Cap for Incandescent or Neon Lamp

Lens/Filter  
Colors Available:

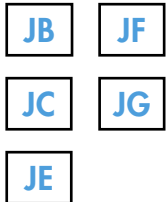

AT4055

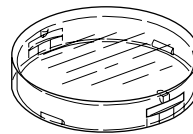
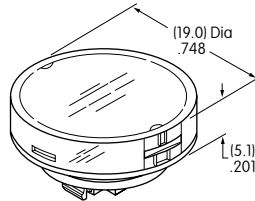

Transparent  
Clear Lens

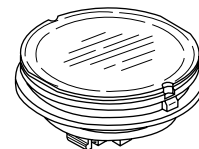

Translucent  
Colored Filter



Lamp  
AT607



Lamp  
AT607N

JF and JG not suitable  
with neon lamp.

Material: Polycarbonate Finish: Glossy

#### Cap for Bright LED without Resistor

Lens/Diffuser  
Colors Available:



AT4179

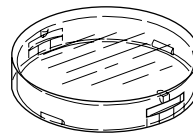
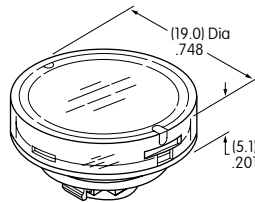

Transparent  
Clear Lens

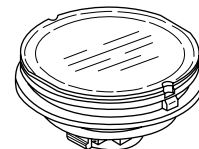

Translucent  
Colored Diffuser



Bright LED  
AT635

Material: Polycarbonate Finish: Glossy

#### Cap for Bright LED with Resistor

Lens/Diffuser  
Colors Available:



AT4165

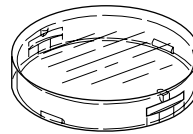
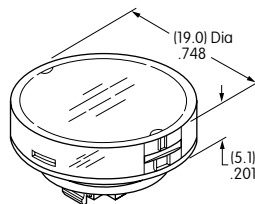

Transparent  
Clear Lens

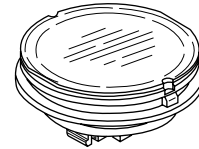

Translucent  
Colored Diffuser

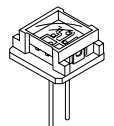

Bright LED  
AT627

Material: Polycarbonate Finish: Glossy

### CAP TYPES & COLOR COMBINATIONS

#### Cap for Super Bright LEDs

**JB**

**Clear Lens  
White Diffuser**

Material:  
Polycarbonate  
Finish: Glossy

**AT4131**

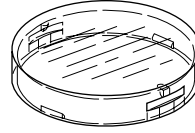
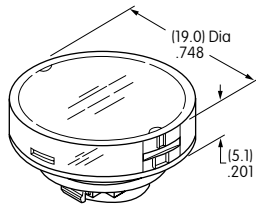

Transparent  
Clear Lens

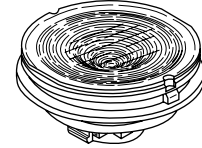

Translucent  
Colored Diffuser



LEDs  
AT625  
AT631  
AT632

### TYPICAL SWITCH DIMENSIONS

#### Panel Seal

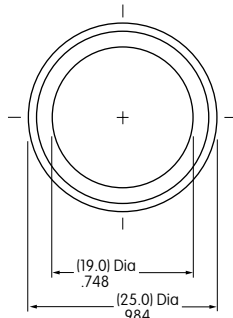

#### Single & Double Pole

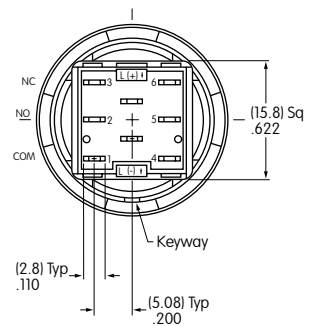
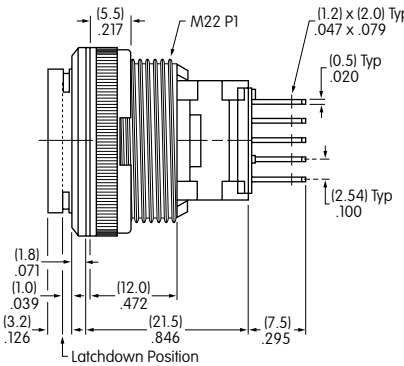

LB25WKW01-12-JC

Single pole models do not have terminals 4, 5, & 6.

### OPTIONAL ACCESSORIES

#### AT9410 Splash Cover for Panel Seal

Materials:  
Lid: PVC (loses pliability below 0°C/32°F)  
Base: Polyethylene  
O-ring: NBR  
Recommended Panel Thickness:  
.039" ~ .138" (1.0mm ~ 3.5mm)

